

Clamping Modules – mechanical

Clamps or swing clamps with universal clamping plate,
max. clamping force 6 and 10 kN

M8.300

Issue 5-20 E

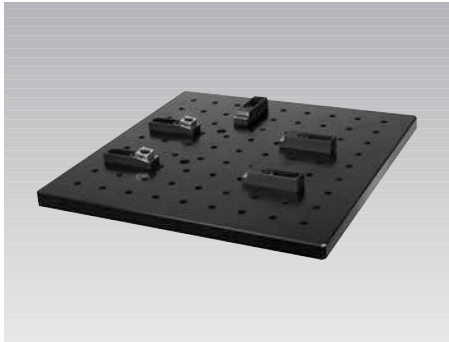

Clamping module with clamps



Clamping module with swing clamps

Advantages

- Quicker and simpler clamping process
- Quick and easy retrofitting
- Optionally clamping module with clamps or swing clamps
- Complete sets including universal clamping plate
- Every point on the universal clamping plate is approachable with the clamping elements
- Easy handling for retrofitting due to universal clamping plate made of aluminium
- Easy fixing of the universal clamping plate on other *modulog* modules by the *modulog* interface

Description

These *modulog* clamping modules are mechanical clamping elements that are offered together with a universal clamping plate as a kit.

Alternatively the clamping modules contain clamps or swing clamps with the corresponding support elements. The universal clamping plate is provided with a grid for mounting of the clamping elements. This allows flexible positioning of the clamping elements for clamping of very different workpieces.

The universal clamping plate is equipped with a 140 x 140 *modulog* interface in the centre, so that it can be easily mounted on other *modulog* modules.

Combined with *modulog* lifting or rotating modules the workpiece can be moved to the ergonomically ideal height or rotating position.

Mounting

The clamping modules are screwed onto the grid of the universal clamping plate with socket head cap screws M12. The screws have to be tightened with 80 Nm.

The universal clamping plate can be mounted with 4 socket head cap screws M10 on other *modulog* modules.

modulog

Clamping modules - mechanical



Clamping module with clamps and universal clamping plate

Max. clamping force: 6 kN

Max. clamping stroke: 2 mm

Operation with Allen key

Part-no. 8903-06-05-O

Clamping module with swing clamps and universal clamping plate

Max. clamping force: 10 kN

Max. clamping stroke: 1.5 mm

Operation with hand lever

Part-no. 8902-10-08-M

Accessory: Height cylinder

Universal clamping plate

with grid 50 mm – M12

with *modulog* interface

140 x 140 mm - counterbore for

DIN 912 M10

Material

Clamping elements: steel, partially hardened

Universal clamping plate: high-tensile aluminium

Important note!

For dimensioning of the clamps it has to be considered if the forces act against a fixed stop or if clamping forces are used by friction.

Application

With *modulog* clamping modules workpieces for manual assembly operations are easily and reliably positioned, fixed and clamped.

Thus the fitter can exert forces on the workpiece without displacing it.

The quality of the assembly process will be improved.

Principal use

- Assembly of heavy components
- Assembly of frequently changing components
- Workshop applications
- Clamping during test cycles
- Machining of cylinder heads
- Assembly of electric motors



ROEMHELD
HILMA ■ STARK

Subject to change.

Carr Lane Roemheld Mfg. Co.

Sales — Phone (636) 386-8022 Fax (636) 386-8034

Engineering — Phone 1-800-827-2526 Web roemheld-usa.com

Clamping module with clamps

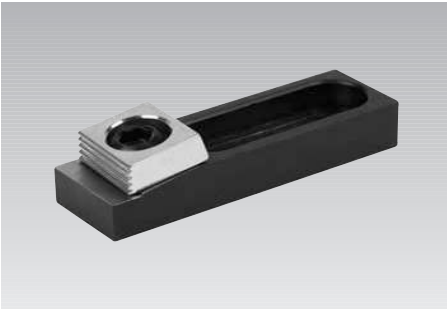

Clamp 6351-642

Description

This clamping module contains 2 clamps and 3 support elements.

Since the clamps can also be used as supports, all in all 5 support surfaces can be realised.

The support elements are designed so that they can also be used as fixed stops. Thus the workpieces can always be reproducibly clamped in the same position.

The clamps and support elements excel by their compactness and precise support and stop faces.

Part numbers

Clamping module with clamps

8903-06-05-0

Delivery:

- 2 off clamps
- 3 off support elements
- 1 off universal clamping plate

Part numbers of individual elements:

Clamp: **6351-642**
 Support element: **6351-643**
 Universal clamping plate: **6311-572**

Technical characteristics

Clamping force (per clamp):	[kN]	6
Extraction force (clamping module):	[kN]	approx. 3
Clamping stroke:	[mm]	max. 2
Support height:	[mm]	12.2

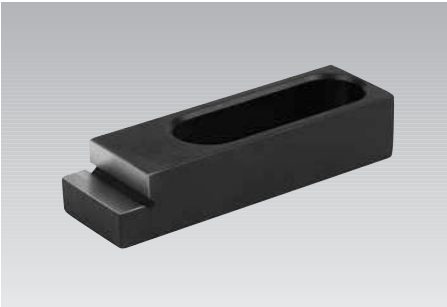

Support element 6351-643

Installation

If possible the workpiece has to be clamped so that the highest forces act against the fixed stop.

The workpiece must safely rest on all support surfaces.

The 2 clamps have to be positioned so that they clamp against the 2 support elements. The 3rd support element can be used as fixed stop across the clamping direction.

With an Allen key SW 8 the clamping eccentric of the clamps is tightened by approx. 1/4 revolution so that the workpiece is safely clamped against the fixed stop.

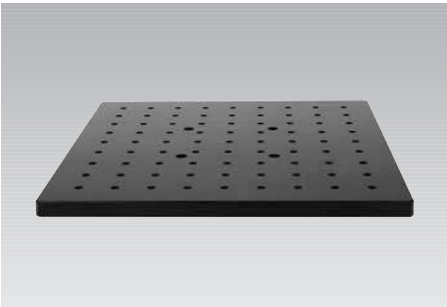

Universal clamping plate 6311-572

Important note!

When mounting, pay attention to the maximum clamping stroke.

Dimensions

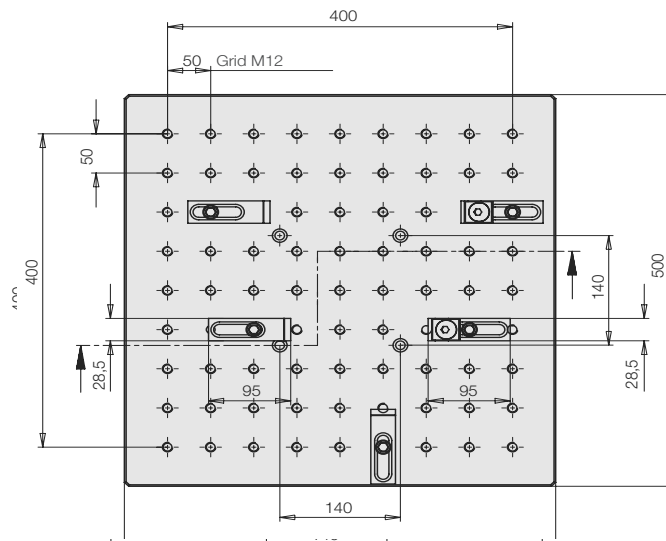
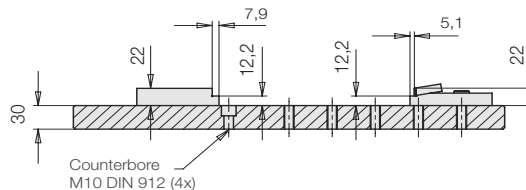

Application example

Assembly of a hydraulic cylinder. The universal clamping plate is mounted on a *modulog* lifting module to easily adjust the optimum working height.

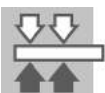
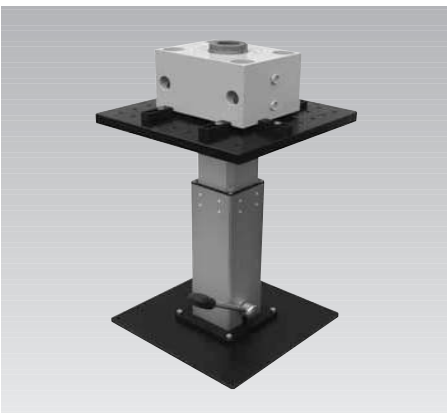

ROEMHELD
 HILMA ■ STARK

Subject to change.

Carr Lane Roemheld Mfg. Co.

Sales — Phone (636) 386-8022 Fax (636) 386-8034

Engineering — Phone 1-800-827-2526 Web roemheld-usa.com

Clamping module with swing clamps



Swing clamp 6351-640

Description

This clamping module contains 4 swing clamps and 4 jack screws. The height of the clamping points of the swing clamps as well as the support height of the jack screws can be adjusted. This allows clamping of workpieces with support points in different heights. If the adjusting range is not sufficient, it can be enlarged by means of the accessory height cylinder. The clamping module with mechanical swing clamps excels by its flexibility and variety.

Part numbers

Clamping module with swing clamps

8902-10-08-M

Delivery:

- 4 off swing clamps
- 4 off jack screws
- 1 off universal clamping plate

Part numbers individual elements:

Swing clamp: **6351-640**
 Jack screw: **6351-641**
 Universal clamping plate: **6311-572**



Jack screw 6351-641

Installation

First the 4 jack screws are positioned to the appropriate height and then locked with an open-end wrench SW36/SW30. The workpiece must safely rest on the support surfaces. The 4 swing clamps have to be positioned so that they clamp against the 4 jack screws. For clamping the clamping arms are manually swung above the clamping points. By operation of the clamping lever the clamping process is effected.

Technical characteristics

Max. clamping force (per swing clamp):	[kN]	10
Extraction force (clamping module):	[kN]	> 10
Clamping stroke:	[mm]	max. 1.5
Basic height:	[mm]	68 up to 98
Support height:	[mm]	50 up to 70

Accessory

Height cylinder 50 mm
Part-number 6311-632

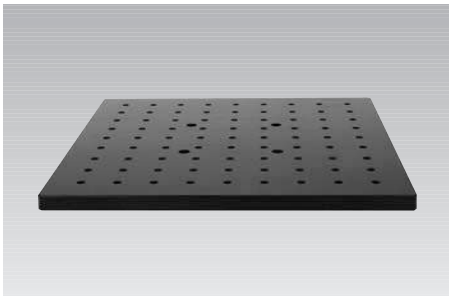
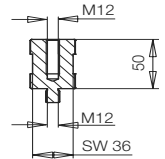

Universal clamping plate 6311-572

Important note!

When mounting, pay attention to the maximum clamping stroke.

Dimensions

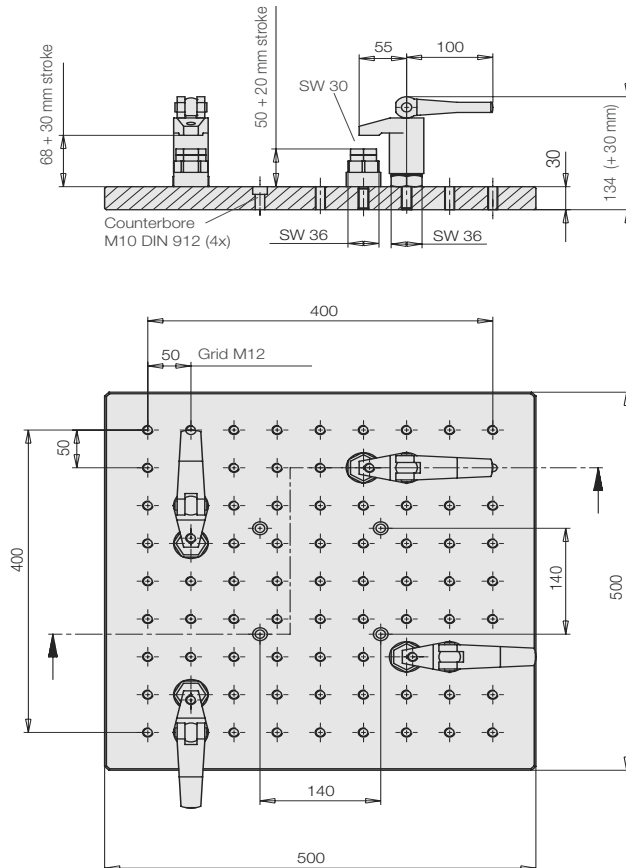

ROEMHELD
 HILMA ■ STARK

Subject to change.

Carr Lane Roemheld Mfg. Co.

Sales — Phone (636) 386-8022 Fax (636) 386-8034

Engineering — Phone 1-800-827-2526 Web roemheld-usa.com