

Application:

Electrically driven high-pressure hydraulic unit for operating small and midsize clamping systems. Suitable for both single-acting and double-acting cylinders. Unit operates intermittently with automatic pressure controls. The required operating pressure is preset on a pressure switch that controls the motor. When the set pressure is reached, the motor is automatically switched off. If the pressure drops 10% below the set value, the pressure switch starts the motor again.

Description:

Complete with motor, pump, oil tank, manifold block, pressure gauge, pressure switch, valves and electrical system. The radial piston pump is bi-directional and fixed displacement. Zero leakage poppet type directional valves. Electrical system is to US standards. The control voltage (24VDC or 120VAC) is supplied by the customer. The oil level and temperature sensor is standard. Optional equipment includes remote control pendant and machine safety pressure switches.

Die lifter circuit:

The low pressure die lifter circuit provides an adjustable reducer with a circuit relief valve. The high pressure die lifter circuit operates at full system pressure. Both include a circuit relief valve which reduces possible pressure intensification caused by overloading the die lifters.

Advantages:

- ◆ modular unit ready for installation
- ◆ compact, light weight design
- ◆ zero leak, directional valves maintain clamping pressure in case of power failure
- ◆ highly reliable radial piston pump ensures long service life
- ◆ fluid immersed, direct drive motor, and finned aluminum housing provides optimum efficiency
- ◆ zero leak fittings and valves
- ◆ sight glass for oil level control
- ◆ oil temperature/level switch

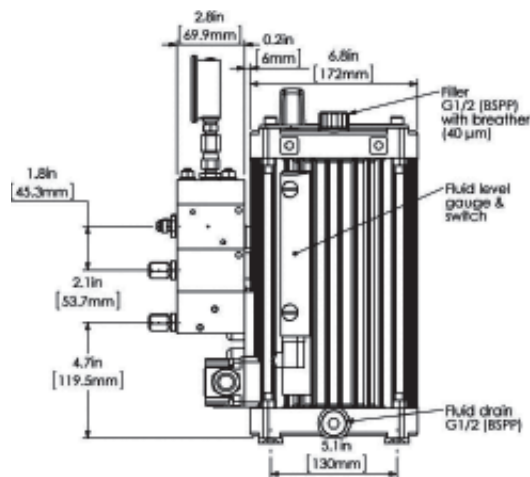
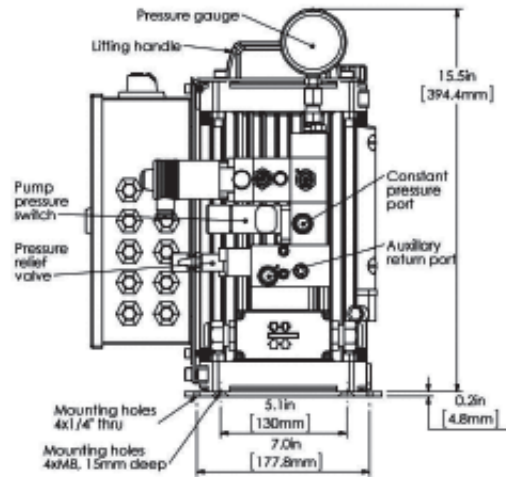

	230 VAC 3Ø	460 VAC 3Ø
Max. pressure	400 bar (5800 psi) ¹	
Power supply frequency	60 Hz	
Control voltage	120 VAC or 24 VDC ²	
Flow rate	1.8 L/min (110 cu.in./min) ¹	
Usable fluid capacity	1.85 L (112 cu.in.) ¹	
Reservoir capacity	3.9 L (238 cu.in.) ¹	
Power @ max. pressure	0.75 kW (1 hp)	0.9 kW (1.2 hp)
Motor amperage	3.9 amps	2.1 amps
Noise level @ 1 meter (3.3 feet)	65 dBA	
Max. duty cycle	25-40 %	
Approx. weight w/ one valve & oil	25 kg / 55 lbs	

¹Different flow rates, max. pressures and tank sizes available upon request.
²Control voltage supplied by customer.

Electric power unit compact



ROEMHELD
HILMA ■ STARK

Ordering example

HCR-PE-6-2001-110

Pump type

Control Configuration

Double-acting clamp

Single-acting clamp

Low pressure die lifter

High pressure die lifter

Without remote pendant

Electric control

Valve package/monitoring system

Pump Type

6	Hydraulic unit, 110 cu. in./min. @ 5800 PSI
---	---

Control Configuration

	Double acting clamp circuit	Single acting clamp circuit	Die Lifter		Application, Special features
			Low Pressure 550 - 5500 PSI	High Pressure 5800 PSI	
0100	0	1	0	0	1 single-acting clamp circuit
0101	0	1	0	1	1 single acting clamp circuit and high pressure die lift circuit
0110	0	1	1	0	1 single-acting clamp circuit and low pressure die lift circuit
1000	1	0	0	0	1 double-acting clamp circuit
1001	1	0	0	1	1 double-acting clamp circuit and high pressure die lift circuit
1010	1	0	1	0	1 double-acting clamp circuit and low pressure die lift circuit
1100	1	1	0	0	1 double-acting clamp circuit and 1 single-acting clamp circuit
1101	1	1	0	1	1 double-acting clamp circuit, 1 single-acting clamp circuit and 1 high pres. die lift circuit
1110	1	1	1	0	1 double-acting clamp circuit, 1 single-acting clamp circuit and 1 low pres. die lift circuit
2000	2	0	0	0	2 double-acting clamp circuits
2001	2	0	0	1	2 double-acting clamp circuits and 1 high pressure die lift circuit
2010	2	0	1	0	2 double-acting clamp circuits and 1 low pressure die lift circuit

Valve Package/Monitoring System

	Valve Voltage		Press Enable Pressure Switch	Temp/Level Switch
	110 VAC	24 VDC		
0				✓
1	✓			✓
2	✓		✓	✓
3		✓		✓
4		✓	✓	✓

Electric Control

	Without Electric	With Terminal Box	460 Volts 3 Phase 60 Hz
1	With Electric	For Remote Pendant	
	Without Electric	With Terminal Box	230 Volts 3 Phase 60 Hz
3	With Electric	For Remote Pendant	

Remote Pendant

0	Without Remote Pendant
---	------------------------

Pressure relief valve and pressure switch:

Operating pressure infinitely adjustable from 725 to 5,800 psi.

Directional seat valves:

With HAWE hole patterns, mounting dimensions as per HAWE spec sheet D7300, size 1.

Machine Safety:

Pressure switch connected to the machine control system. Switch setting is 15% (min.) below clamping pressure. Machine operation is allowed only when set pressure is reached. If pressure drops below setting, machine is automatically stopped.

Oil level and temperature switch:

Both oil level and temperature switch are provided to automatically switch off the pump motor if there is lack of oil or the temperature exceeds 140°F.

With electric, for remote pendant or control panel:

Hydraulic unit can be supplied ready to install with the necessary circuit breakers, motor starter, overload protection, etc., already wired to an electrical enclosure for use with remote pendant, or control panel. Power for valve control is supplied by customer.

Without electric, with terminal box:

Optionally, the unit can be supplied with just the motor, valves, and pressure switch wired to a terminal strip. This is often desired for new machine controls.

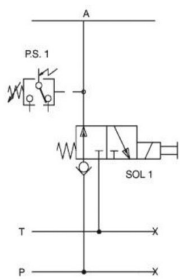

HCR-PE-60100
(1) Single acting clamp

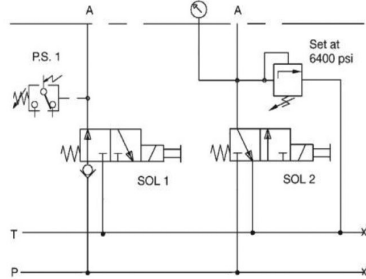

HCR-PE-60101
(1) Single acting clamp
(1) High pressure die lift

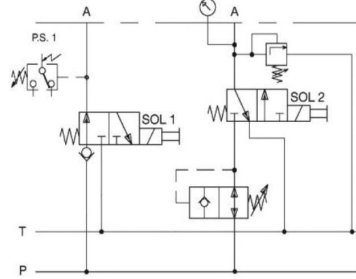

HCR-PE-60110
(1) Single acting clamp
(1) Low pressure die lift

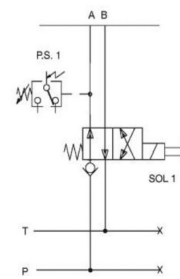

HCR-PE-61000
(1) Double acting clamp

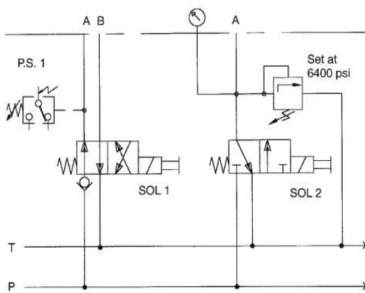

HCR-PE-61001
(1) Double acting clamp
(1) High pressure die lift

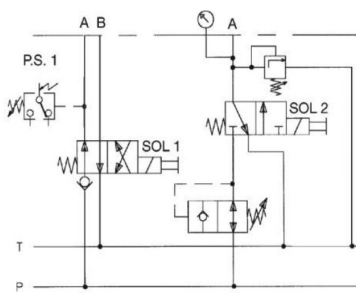

HCR-PE-61010
(1) Double acting clamp
(1) Low pressure die lift

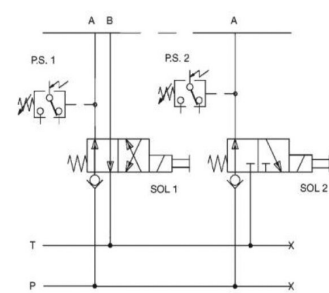

HCR-PE-61100
(1) Double acting clamp
(1) Single acting clamp

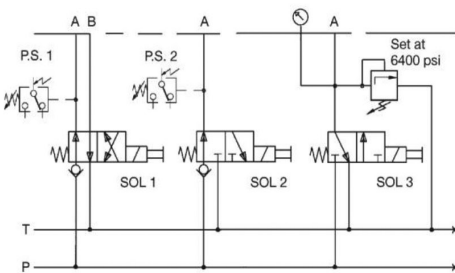

HCR-PE-61101
(1) Double acting clamp
(1) Single acting clamp
(1) High pressure die lift

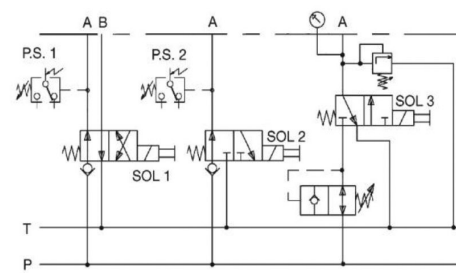

HCR-PE-61110
(1) Double acting clamp
(1) Single acting clamp
(1) Low pressure die lift

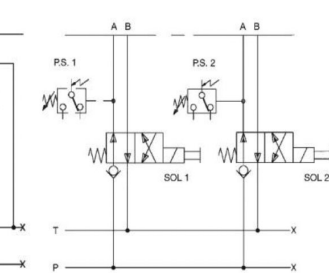

HCR-PE-62000
(2) Double acting clamp

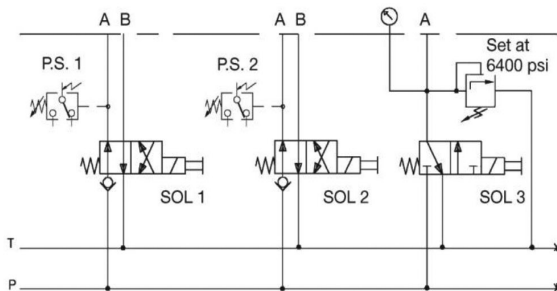

HCR-PE-62001
(2) Double acting clamp
(1) High pressure die lift

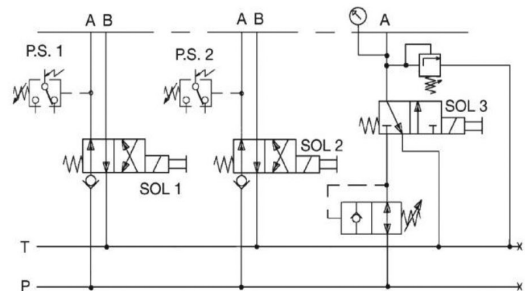

HCR-PE-62010
(2) Double acting clamp
(1) Low pressure die lift