

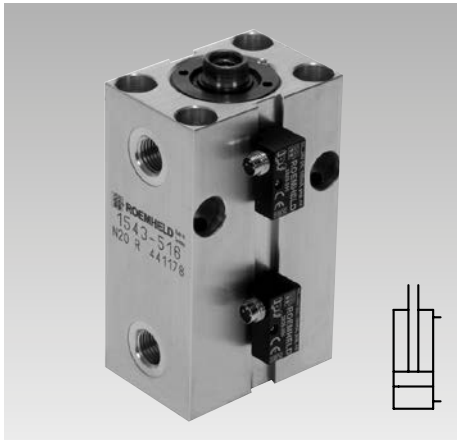

Block Cylinders

with aluminium or bronze housing for adjustable magnetic sensors, double acting, max. operating pressure 350 bar or 500 bar



Advantages

- 5 sizes with 3 stroke lengths
- Compact block design
- Same dimensions as block cylinder with steel housing, except for total length
- Multiple fixing possibilities
- Fixing screws countersunk
- Many connecting possibilities
- Magnetic sensors can be used up to 100 °C
- Fixing of the sensors at 2 sides possible
- Easy adjustment of switching point positions
- Piston rod case-hardened
- Stainless steel version optional
- Alternatively NBR or FKM seals
- Minimum leakage due to double rod seal
- Maintenance free

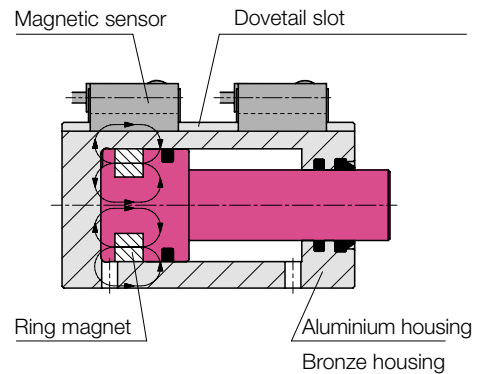

Application

Hydraulic block cylinders are universally used for all linear movements with high force requirements and very small dimensions. With the adjustable magnetic sensors certain piston positions can be controlled exactly.

Function

The double-acting function ensures high function safety as well as exactly calculable and repeatable stroke times.

Description

The piston of these block cylinders is equipped with a ring-shaped magnet whose magnetic field actuates the sensor. The cylinder housing is therefore made of a non-magnetisable material.

Two variants are available:

- 154X X1X High-tensile aluminium alloy max. operating pressure 350 bar
- 154X X5X High-tensile bronze alloy max. operating pressure 500 bar

The magnetic sensors are guided in dovetail slots and allow a continuous control of the piston position.

Punching applications

- 154X X1X Block cylinder with aluminium housing
Not suitable for punching applications!
- 154X X5X Block cylinder with bronze housing
Suitable with the following restrictions:
– max. operating pressure 250 bar
– only with external guide and tool stop

Important notes

Block cylinders are intended exclusively for industrial applications and may only be operated with hydraulic oil.

They can generate very high forces to be absorbed by the fixture or the machine.

In the effective area of the piston rod there is the danger of crushing. The manufacturer of the fixture or the machine is obliged to provide effective protection devices.

Fixing possibilities

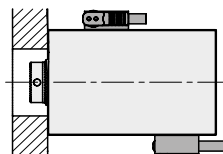

● **Broad side**

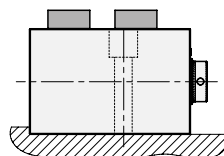

● **Rod side**

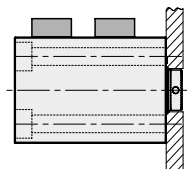

● **Bottom side**

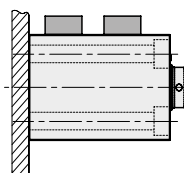

Hydraulic connecting possibilities

Pipe thread

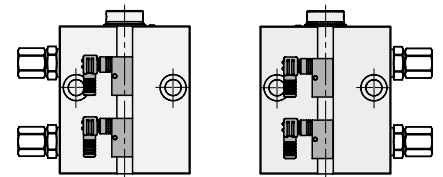

Flange with O-ring sealing

● **Broad side**

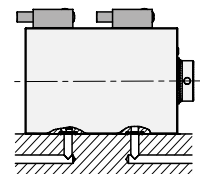

● **Rod side**

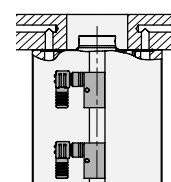

● **Bottom side**

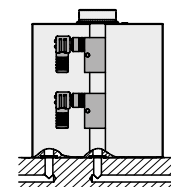

Further notes see page 3.

Pipe thread

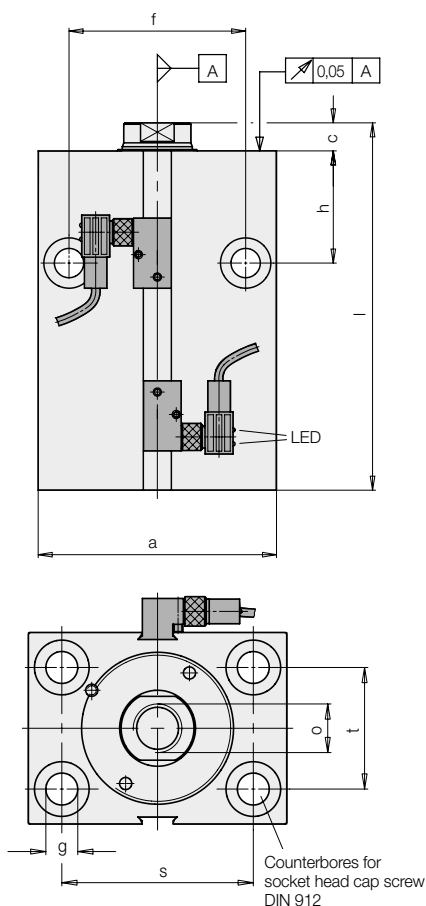
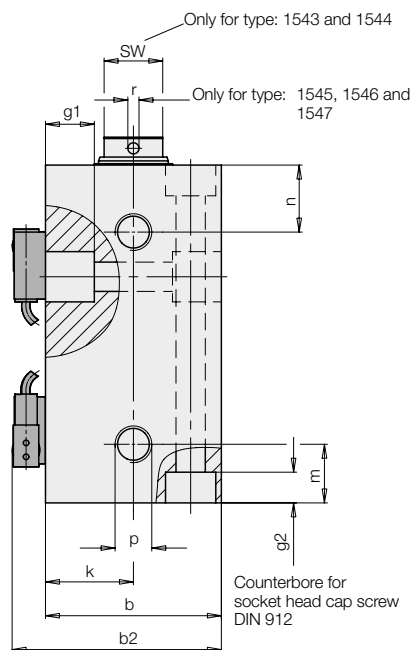

Accessories:
Magnetic sensors see data sheet G 2.140

Materials

Cylinder body:	aluminium alloy (350 bar) bronze alloy (500 bar)
Piston:	case-hardening steel, hardened and ground or stainless steel hardened and ground
Threaded bushing:	free-cutting steel or stainless steel, hardened and tempered

Use only fixing screws 8.8!

Size		1543	1544	1545	1546	1547
Piston Ø	[mm]	25	32	40	50	63
Piston rod Ø	[mm]	16	20	25	32	40

Stroke +/- 0.7	[mm]	20	25	25	25	30
Total length l +/- 0.8	[mm]	85	100	106	117	135

Aluminium housing max. 350 bar						
Weight	[kg]	0.68	1.1	1.52	2.6	4.4
Part no. (NBR)		1543513	1544513	1545513	1546513	1547513

Bronze housing max. 500 bar						
Weight	[kg]	1.04	2.24	3.1	5.1	8.43
Part no. (NBR)		1543553	1544553	1545553	1546553	1547553

Stroke +/- 0.7	[mm]	50	50	50	50	63
Total length l +/- 0.8	[mm]	115	125	131	142	168

Aluminium housing max. 350 bar						
Weight	[kg]	0.9	1.37	1.94	3.1	5.45
Part no. (NBR)		1543516	1544516	1545516	1546516	1547516

Bronze housing max. 500 bar						
Weight	[kg]	1.94	2.8	3.7	6	11
Part no. (NBR)		1543556	1544556	1545556	1546556	1547556

Stroke +/- 0.7	[mm]	100	100	100	100	100
Total length l +/- 0.8	[mm]	165	175	181	192	205

Aluminium housing max. 350 bar						
Weight	[kg]	1.32	1.86	2.74	4.1	7.5
Part no. (NBR)		1543519	1544519	1545519	1546519	1547519

Bronze housing max. 500 bar						
Weight	[kg]	3.7	4	5.5	8.2	16.2
Part no. (NBR)		1543559	1544559	1545559	1546559	1547559

Part-no. for pipe thread connection	154X5XX	NBR seals see chart
	154X X2X	FKM seals with aluminium housing
	154X X6X	FKM seals with bronze housing
	154X 4XX	Stainless steel version

Dimensions

Technical data • Important notes

Size			1543	1544	1545	1546	1547
Piston Ø	[mm]		25	32	40	50	63
Piston rod Ø	[mm]		16	20	25	32	40
Effective piston area	stroke to extend	[cm ²]	4.91	8.04	12.56	19.63	31.17
	stroke to retract	[cm ²]	2.9	4.9	7.65	11.59	18.6
Force to push at	100 bar	[kN]	4.91	8.04	12.56	19.63	31.17
	350 bar	[kN]	17.1	28.1	43.9	68.7	109
	500 bar	[kN]	24.5	40.2	62.8	98.1	155.8
Force to pull at	100 bar	[kN]	2.9	4.9	7.65	11.59	18.6
	350 bar	[kN]	10.1	17.1	26.7	40.5	65.1
	500 bar	[kN]	14.5	24.5	38.2	57.9	93
Oil volume per 10 mm stroke	stroke to extend	[cm ³]	4.91	8.04	12.56	19.63	31.17
	stroke to retract	[cm ³]	2.9	4.9	7.65	11.59	18.6
a	[mm]		65	75	85	100	125
b	[mm]		45	55	63	75	95
b2	[mm]		57	67	75	87	107
c	[mm]		7	10	10	10	14
f	[mm]		50	55	63	76	95
g	[mm]		8.5	10.5	10.5	13	17
g1 at both sides	[mm]		12	16	17	22	-*
g2 at both sides	[mm]		9	11	11	13	17
h	[mm]		33	38	40	44	50
h1	[mm]		40	42	44	47	60
k	[mm]		22.5	27.5	31.5	37.5	47.5
m	[mm]		18	20	21	21	26
n	[mm]		18	22	24	27	26
o x depth of thread	[mm]		M10 x 15	M12 x 15	M16 x 25	M20 x 30	M27 x 40
p			G 1/4	G 1/4	G 1/4	G 1/4	G 1/2
r	[mm]		-	-	4	4	4
s	[mm]		50	55	63	76	95
t	[mm]		30	35	40	45	65
u +/- 0.05	[mm]		1.1	1.1	1.1	1.1	1.3
v1	[mm]		4	5	6	6	8
v2	[mm]		4	4.5	4.5	6	6
w + 0.2	[mm]		9.8	10.8	10.8	10.8	15.8
x	[mm]		21.5	25	27	30	35
y	[mm]		21	25	27	29.5	32
SW	[mm]		13	17	-	-	-

* Size 1547 without counterbores

Important notes!

Housing support

When fastened across the cylinder axis, block cylinders must be supported depending on the operating pressure.

Alternative: Keyway (see page 5)

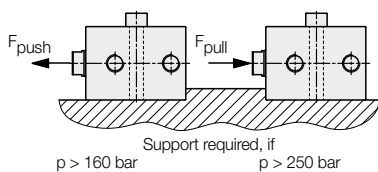

Admissible dynamic load

The max. piston speed is 0.25 m/s. Without effective stroke end cushioning, a mass attached to the piston will move unbraked against the internal stop.

Therefore the following applies:

"For piston speeds exceeding 0.05 m/s and a mass greater than the dead weight of the cylinder, an external stop must be provided."

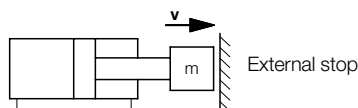

Influence of the magnetic field

Due to iron in the immediate vicinity of the block cylinder the magnetic field of the piston will be deflected. The switching points of the magnetic sensors must then be readjusted.

If no defined switching point can be adjusted, one can try again with stainless steel fixing screws.

With ferritic swarf, the conditions change from stroke to stroke. An exact adjustment is no longer possible. A cover with a minimum distance of 30 mm will help.

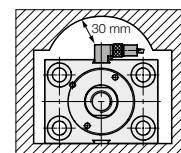

Fittings

Use only fittings with elastic sealing instead of knife-edge sealing (see F 9.300).



DIN 3852 T11 form E and EN ISO 1179-2

Throttling of the flow rate

The throttling must take place in the supply line to avoid pressure intensification and thus pressures that exceed the maximum operating pressure.

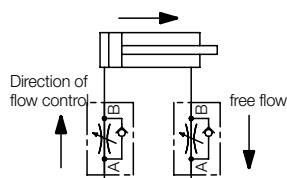

Side loads

Side loads should be avoided because they cause more or less wear to the piston guide and thus produce ferritic mini-particles (see "Cleanness of the hydraulic oil").

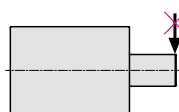

Cleanness of the hydraulic oil

Ferritic swarf in the hydraulic oil are attracted by the permanent magnet at the piston, accumulate in the cylinder area and damage seals and guides. Flush all drilled channels, pipes and hoses thoroughly before start up.

Recommendation: High-pressure filter with 10 µm Filter fineness (see data sheet F9.500).

Admissible operating pressure

Magnetic sensor	154X X1X NBR	154X X2X FKM
without	-30...+100 °C	-20...+120 °C
with	-25...+100 °C	-20...+100 °C

Accessory - Contact bolts

Different contact bolts see data sheet G3.800-

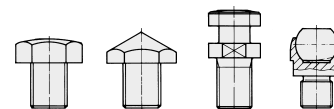

Other data see data sheet A0.100.

Flange with O-ring sealing

Broad side K
Stroke 1 – 49 mm
2 cross holes
154X XXXK

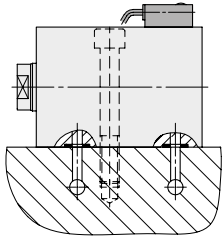

Broad side L
from 50 mm stroke
4 cross holes
154X XXXL

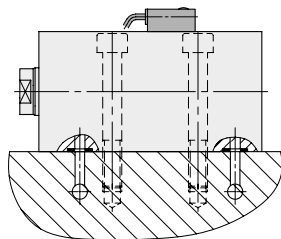

Rod side S
All strokes
4 longitudinal holes
154X XXXS

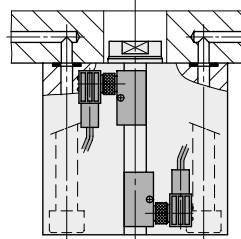

Bottom side B
All strokes
4 longitudinal holes
154X XXXB

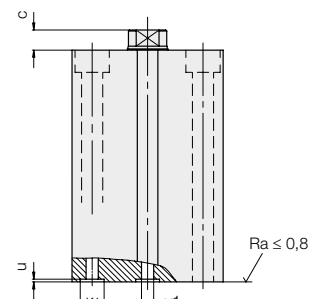
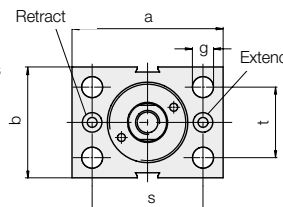
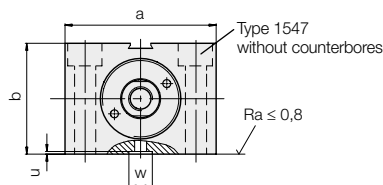
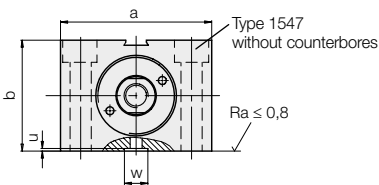
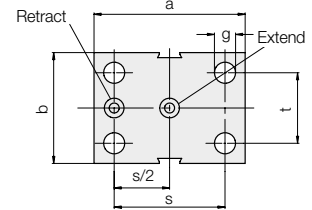
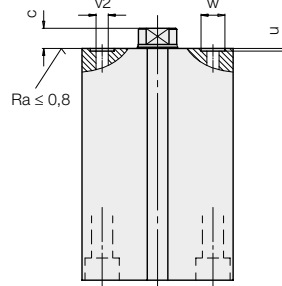
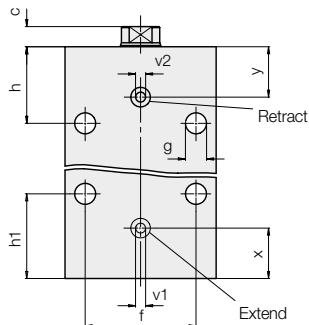
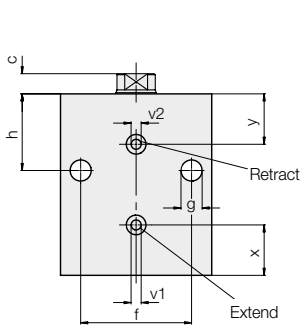
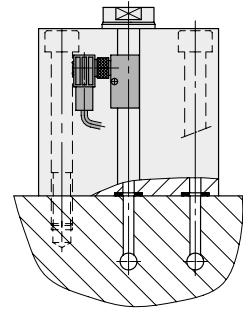

Size		1543	1544	1545	1546	1547
Piston Ø	[mm]	25	32	40	50	63
Piston rod Ø	[mm]	16	20	25	32	40

Stroke +/- 0.7	[mm]	20	25	25	25	30
Total length l +/- 0.8	[mm]	85	100	106	117	135

Aluminium housing max. 350 bar						
Weight	[kg]	0.68	1.1	1.52	2.6	4.4
Part no. (NBR)		1543513X	1544513X	1545513X	1546513X	1547513X

Bronze housing max. 500 bar						
Weight	[kg]	1.04	2.24	3.1	5.1	8.43
Part no. (NBR)		1543553X	1544553X	1545553X	1546553X	1547553X

Stroke +/- 0.7	[mm]	50	50	50	50	63
Total length l +/- 0.8	[mm]	115	125	131	142	168

Aluminium housing max. 350 bar						
Weight	[kg]	0.9	1.37	1.94	3.1	5.45
Part no. (NBR)		1543516X	1544516X	1545516X	1546516X	1547516X

Bronze housing max. 500 bar						
Weight	[kg]	1.94	2.8	3.7	6	11
Part no. (NBR)		1543556X	1544556X	1545556X	1546556X	1547556X

Stroke +/- 0.7	[mm]	100	100	100	100	100
Total length l +/- 0.8	[mm]	165	175	181	192	205

Aluminium housing max. 350 bar						
Weight	[kg]	1.32	1.86	2.74	4.1	7.5
Part no. (NBR)		1543519X	1544519X	1545519X	1546519X	1547519X

Bronze housing max. 500 bar						
Weight	[kg]	3.7	4	5.5	8.2	16.2
Part no. (NBR)		1543559X	1544559X	1545559X	1546559X	1547559X

Spare O-rings		7 x 1.5	8 x 1.5	8 x 1.5	8 x 1.5	12.42 x 1.78
Part no. (NBR)		3000342	3000343	3000343	3000343	3000335
Part no. (FKM)		3001077	3000275	3000275	3000275	3001152

Part-no. for flange type	154X5XXX	Flange K, L, S, B (see above), NBR seals
	154X2XX	FKM seals with aluminium housing
	154X6XX	FKM seals with bronze housing
	154X4XX	Stainless steel version

Standard variants

Thread • Keyway • Stroke limitation

4 threads at the front to fix the housing C, D

Instead of longitudinal holes and cross holes the block cylinders can be provided with 4 interior threads, alternatively at the rod side C or at the bottom side D.

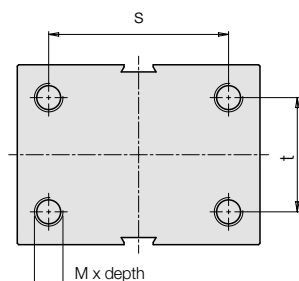

Rod side: 15XXXXXC

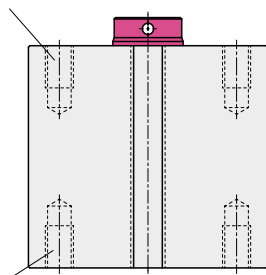

Bottom side: 15XXXXXD

Keyway to support the housing E, F, Q

The block cylinders without longitudinal bore or interior thread can be provided with a keyway for a key.

For pipe thread connection the position of the connecting threads have to be determined in advance (identification code E or F). For flange-type connection (K or L) the identification code is Q.

Pipe thread connection at the right side: 15XXXXXE

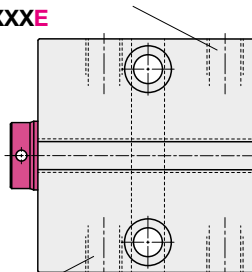

Pipe thread connection at the left side: 15XXXXXF

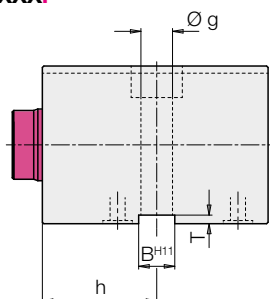

Flange-type connection: 15XXXXXQ

Stroke limitation by distance bushing H

The extending piston stroke of block cylinders can be limited by installing a distance bushing. The minimum stroke should not be less than 1 mm. The maximum possible stroke starting from the the standard stroke is indicated in the below chart.

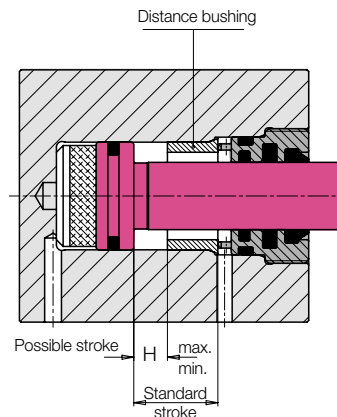

Example: Possible stroke

Block cylinder 1545516
Standard stroke 50 mm

As per table:

Hmin. = 1 mm

Hmax. = 50 – 3 = 47 mm

Possible combinations of standard variants see page 6.

Basic type	Dimensions									
	4 threads C, D			Keyway E, F, Q				Stroke limitation H		
Part no. (page 2 to 4)	M x depth	s	t	B ^{H11}	T	Ø g	h	Hmin.	Hmax.	
1543XXXX	M 8 x 12	50	30	10	2	8.5	33	1	Standard stroke – 3	
1544XXXX	M 10 x 15	55	35	12	3	10.5	38	1	Standard stroke – 3	
1545XXXX	M 10 x 15	63	40	12	3	10.5	40	1	Standard stroke – 3	
1546XXXX	M 12 x 18	76	45	15	5	13	44	1	Standard stroke – 4	
1547XXXX	M 16 x 24	95	65	20	5	17	50	1	Standard stroke – 4	

General tolerances as per DIN ISO 2768-mH

All dimensions in mm.

Examples for ordering:

4 threads

Block cylinder 1547513
(pipe thread connection)
with 4 threads M16 at the bottom side

Part no. 1547513D

Block cylinder 1547516
(pipe thread connection)
with 4 threads M16 at the rod side

Part no. 1547516C

Block cylinder 1547513B
(flange-type connection)
with 4 threads M16 at the bottom side

Part no. 1547513BD

Keyway

Block cylinder 1546523
(pipe thread connection)
with keyway and connecting thread
at the right side

Part no. 1546523E

Block cylinder 1546513
(pipe thread connection)
with keyway and connecting thread
at the left side

Part no. 1546513F

Block cylinder 1546556L
(flange-type connection)
with keyway

Part no. 1546556LQ

Stroke limitation

Block cylinder 1545513
(pipe thread connection)
with stroke limitation to 12 mm

Part no. 1545513H12

Block cylinder 1545519
(pipe thread connection)
with stroke limitation to 80 mm

Part no. 1545519H80

Block cylinder 1545556LQ
(flange-type connection)
with keyway and stroke
limitation to 40 mm

Part no. 1545556LQH40

Code for part numbers

Code for part numbers of the basic versions*

(page 2 to 4)

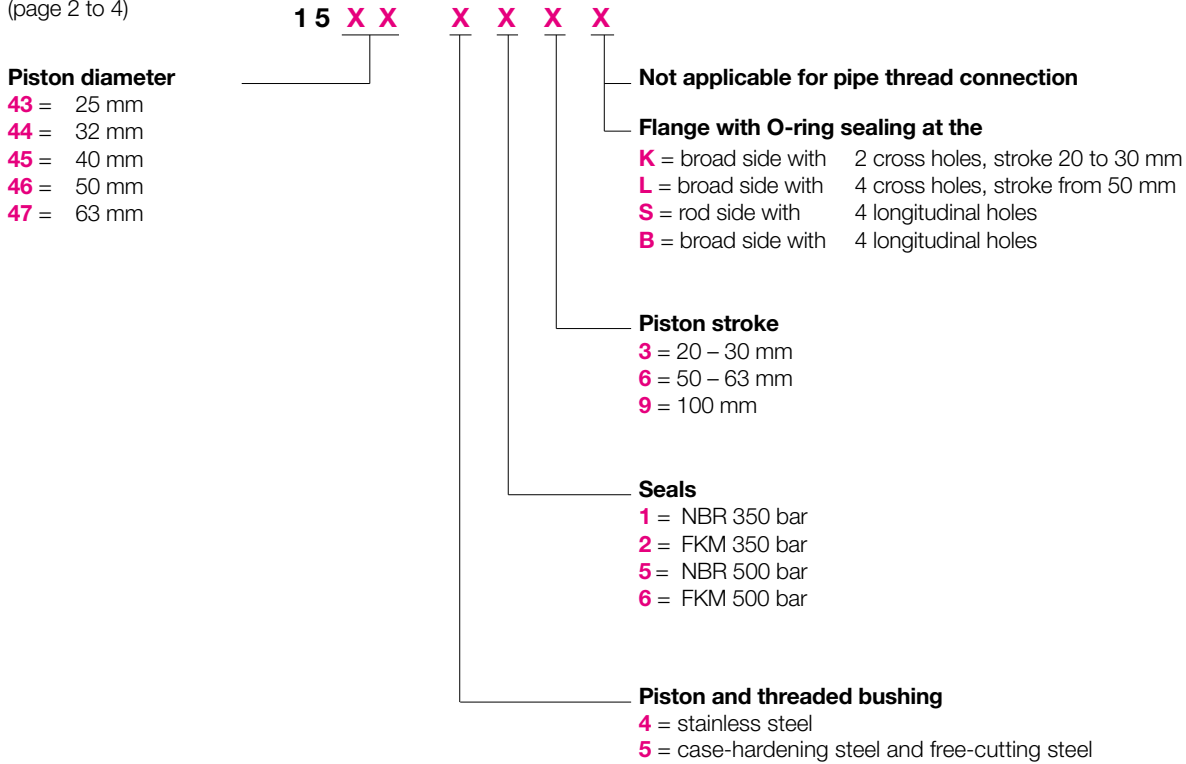

*) Important notes

The code for part numbers enables the determination of the technical data with a known part number. The code for part numbers is not suitable for selecting any variant. Only the versions as per the charts on page 2 or 4 are available as standard elements.

Special variants are available on request.

Code for part numbers of the standards variants and possible combinations

Explanation of the identification codes and order examples see page 5

